

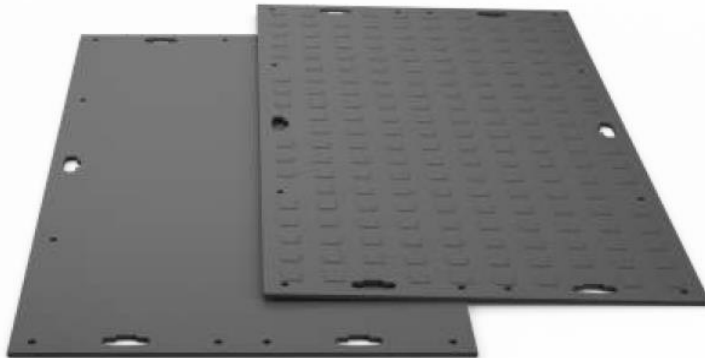

# GEBRAUCHSANLEITUNG INSTALLATIONGUIDE

**VARIO**  
mat 1+



**Laying the panels** (dismantle panels in reverse order)

**Unloading from lorries:**

There are two ways of unloading the panels:

- Manual unloading by 2 persons. The handles provided in the panels make loading and unloading easy.
- Stacks of panels can be unloaded using a forklift truck:  
Care should only be taken to ensure that the forks are long enough (at least 100 cm) and that the individual panels are made safe to stop them falling.

**Storage:**

The panels should be stacked no more than 20 per stack. It is advisable to stack no more than 3 stacks on top of each other. It is also a good idea to put 3 pieces of square timber between stacks.

Panels can be easily handled by two persons.

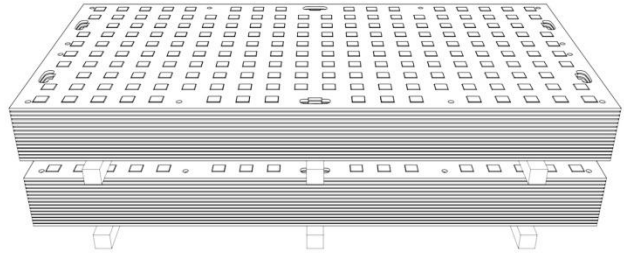

**The panel:**

Material: break-resistant polyethylene  
Dimensions: 1200 mm x 2400 mm x 12 mm  
Weight: 36 kg

Connecting holes to screw panels together are positioned on all 4 sides of each panel.

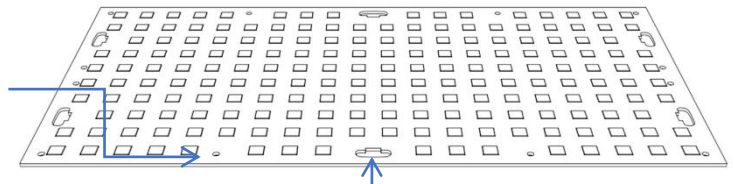

The short sides of each panel have handles.

**2-way connectors:**

Material: PE polymer or metal  
Dimensions: 185 mm x 185 mm x 10 mm  
Weight: 0.1 kg per connector  
Connecting screws:  
Threads: M10 screw/washer  
Weight: 0.1 kg, including washer

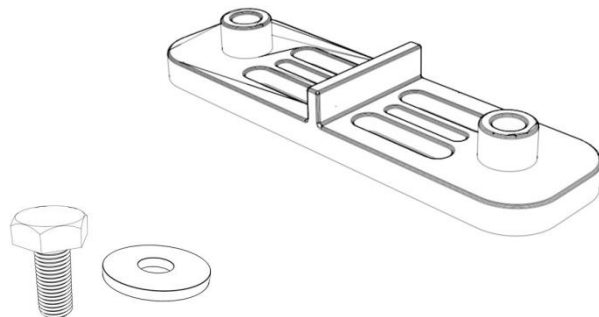

**4-way connectors:**

Material: break-resistant polyethylene  
Dimensions: 185 mm x 55 mm x 10 mm  
Weight: 0.4 kg per connector  
Connecting screws:  
Threads: M10 screw/washer  
Weight: 0.1 kg, including washer

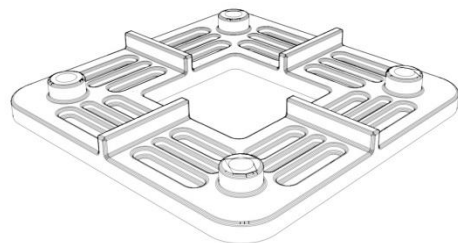

### Laying the panel

Panels can be simply taken off the stack by two persons and transported to the required location.

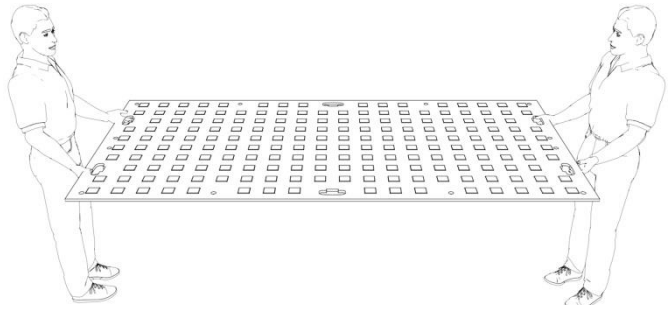

### Laying and mounting panels:

Simply lay panels on top of the floor area to be protected. No pre-treatment of the ground is required.

Panels can best be laid by two people working together.

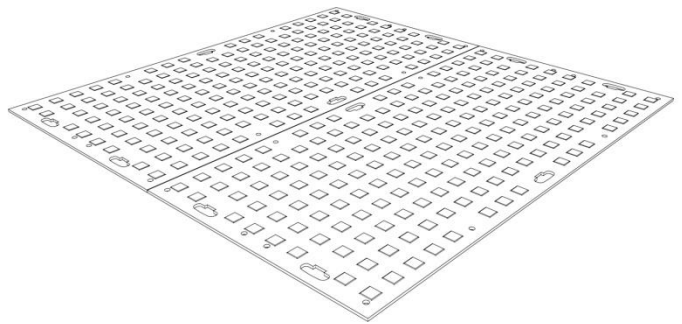

To screw the panels together, simply insert the connectors underneath the panels and then secure them with an M10x25 screw and washer from above.

The best way to screw panels together is to use a cordless screwdriver with an M10 screw bit.

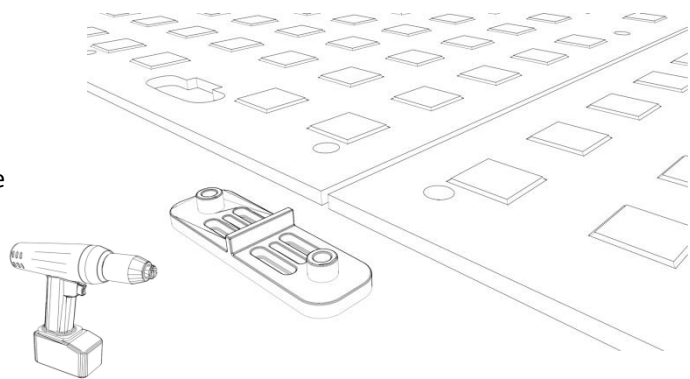

Joining the panels together produces a contiguous surface that protects the ground and distributes pressure when driving on the surface with vehicles.

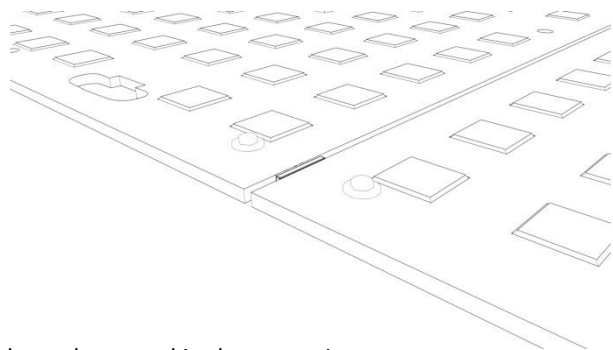

### General notes

#### Surface treatment:

Panels should be cleaned on both sides after use. Panels can be stored in the open air.

However, panels should not be exposed to severe temperatures below freezing.

No special chemical cleaners or tools are required to clean the panels.

A high-pressure cleaner is ideal for cleaning the panels.

#### Use as a temporary access road

The panels are very well suited for use as a temporary access road in open country. Depending on the surface, panels can withstand a load of up to 80 tons per m<sup>2</sup>.

The panels can be used with track vehicles. However, track vehicles should use chain guards whenever possible. Track vehicles should avoid rotating tracks in place, because depending on the pivot point and speed, panels may be torn apart at the screw connections.